

Data Sheet



Article number: 203260M1653A1X

Description: E+G levelling foot

GN 32-60-M16-53-A1-X

Note: X With female thread, External hexagon

Measures

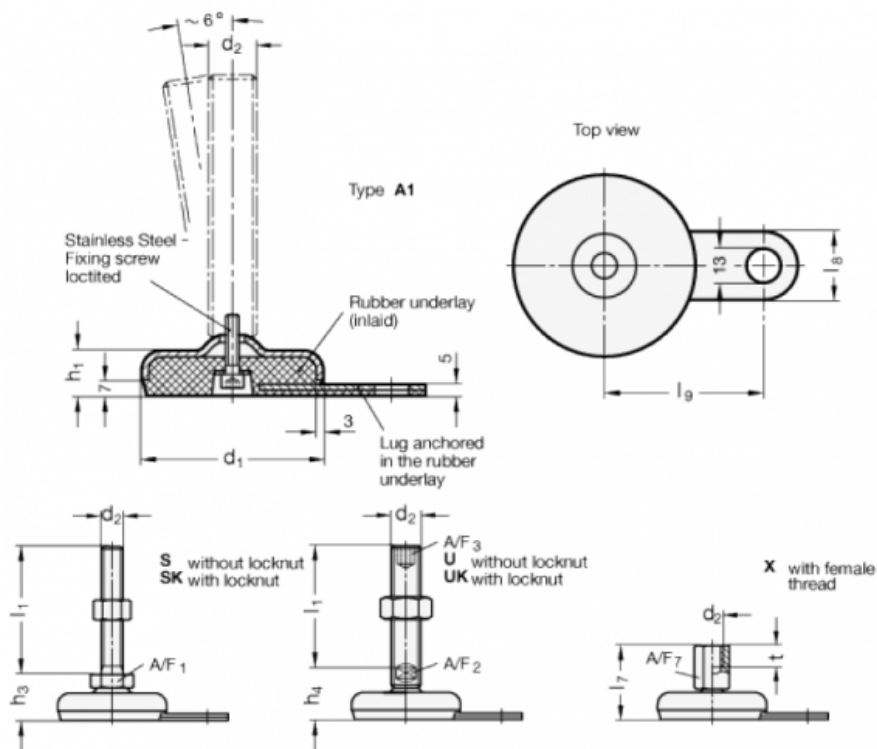

A/F7	=	22
d1	=	60
d2	=	M16
h1	=	19
l7	=	53
l8	=	25
l9	=	50
t	=	16